

INFN:

Istituto

Nazionale di

Fisica

Nucleare



INFN, perchè?

dal nostro sito WEB

- “ L'INFN venne istituito l'8 agosto 1951 da gruppi delle **Università di Roma, Padova, Torino e Milano** al fine di proseguire e sviluppare la tradizione scientifica iniziata negli anni '30 con *le ricerche teoriche e sperimentali di fisica nucleare di Enrico Fermi e della sua scuola.* ”

- *Perche' non semplicemente una collaborazione fra 4 grandi Università?*

- **La ricerca in fisica nucleare e (successivamente) delle particelle ha bisogno di STRUTTURE e di risorse per realizzarle:**
 - *Laboratori*
 - *Officine*
 - *Personale tecnico (e amministrativo)*

INFN, cos'è ?

dal nostro sito WEB

- “ L'INFN, Istituto Nazionale di Fisica Nucleare, è l'istituto che promuove, coordina ed effettua la ricerca scientifica nel campo della **fisica subnucleare, nucleare e astroparticellare**, nonché lo **sviluppo tecnologico necessario alle attività in tali settori**. Opera in stretta connessione con l'Università e nell'ambito della collaborazione e del confronto internazionale. ”
- Le attività di ricerca sono così raggruppate:



FISICA
PARTICELLARE

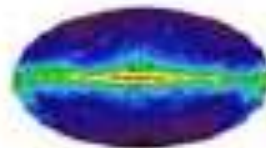

FISICA
ASTROPARTICELLARE

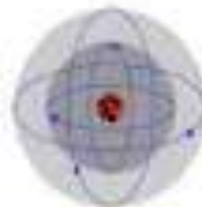

FISICA
NUCLEARE



FISICA
TEORICA



RICERCA
TECNOLOGICA

L' INFN & LA FISICA CON GLI ACCELERATORI

PARTICELLE & NUCLEI

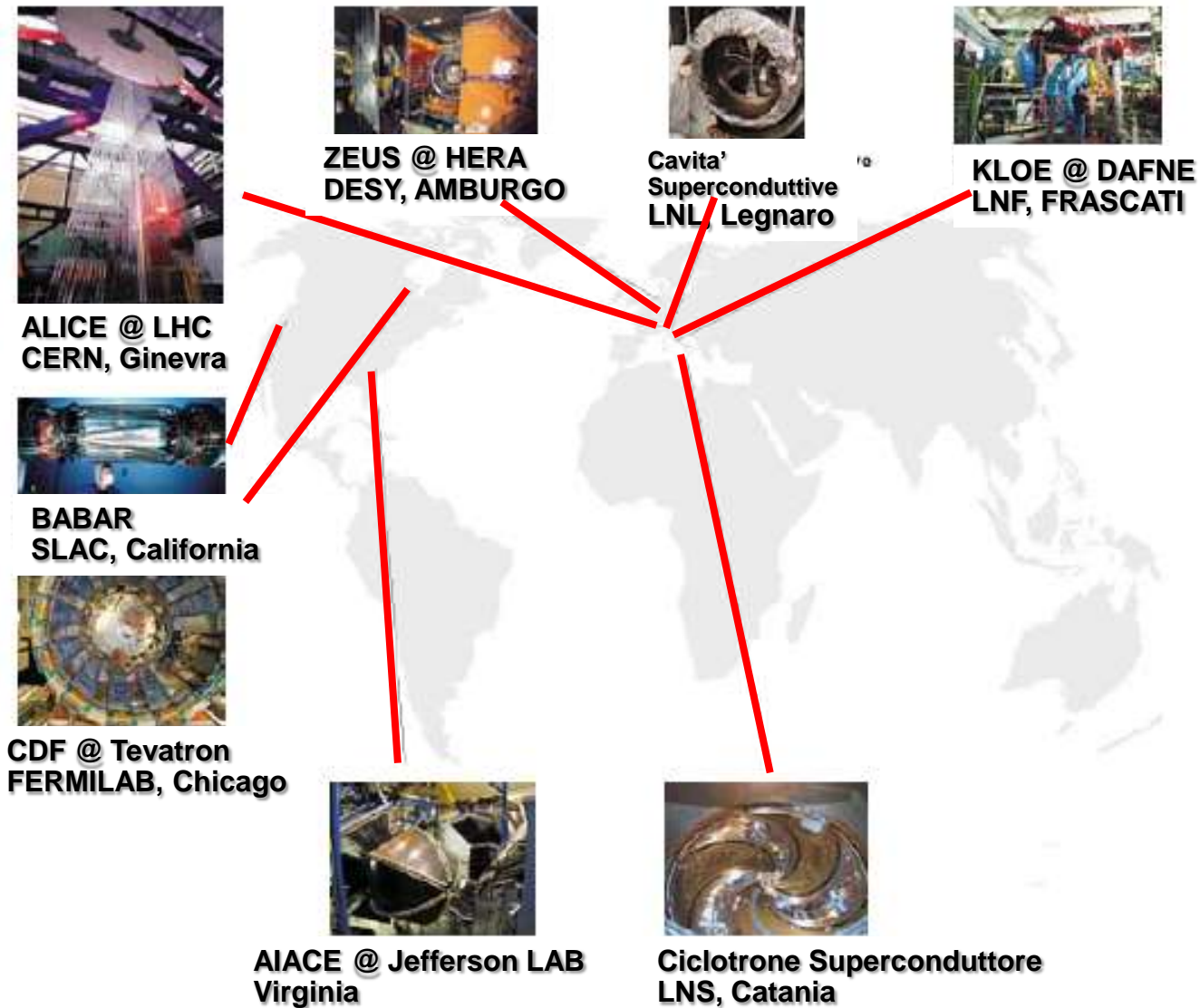

■ Neutrini (ν) da

- **Cosmo**: laboratori nelle profondità marine, NEMO (Sicilia)
- **Sole** : esperimenti GALLEX, GNO, BOREXINO al LNGS
- **Acceleratori** : esperimenti OPERA, ICARUS al LNGS



■ Ricerca di segnali di materia oscura

- Al Gran Sasso, grazie al silenzio della montagna: DAMA, CRESST, HDMS



ASTROPARTICELLE, NEUTRINI
& EVENTI RARI

- **Segnali dal cosmo**
 - I raggi gamma di alta energia- **MAGIC** (Canarie, 2000 m)
- **Onde gravitazionali prodotte da masse accelerate:**
 - **VIRGO**, in Toscana (interferometri ottici)
 - barre ultracriogeniche Nautilus (Frascati) e Auriga (Legnaro) (barre risonanti)
- **Spettrometri volanti per studiare la composizione dei raggi cosmici**
 - **PAMELA**
 - **AMS**

MAGIC



VIRGO



PAMELA

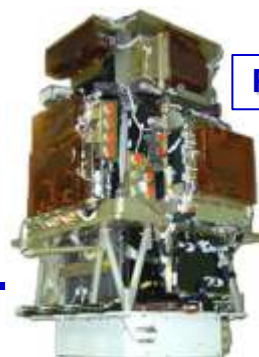

AMS montato sullo SHUTTLE



INFN - SVILUPPO TECNOLOGICO

I 3 PILASTRI TECNOLOGICI PER LA SPERIMENTAZIONE

- **ACCELERATORI DI PARTICELLE**



- **RIVELATORI DI PARTICELLE**



- **CALCOLO**



particle accelerators with increasing energy and intensity

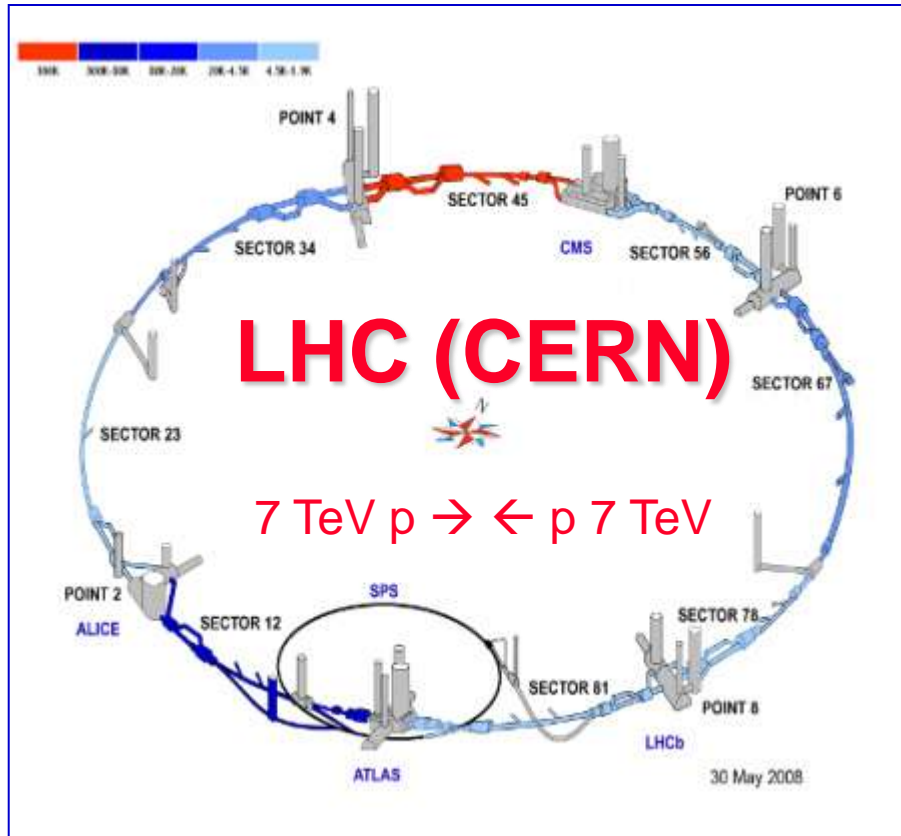

OPERATION STARTED: 2ND HALF 2009

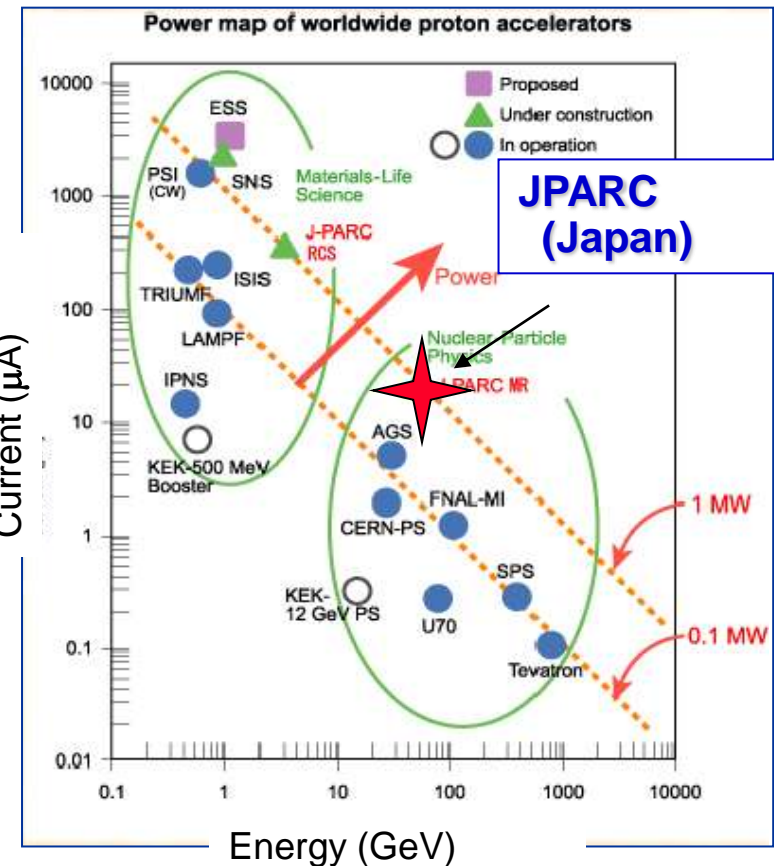

OPERATION STARTED: 4TH QUARTER 2008

MACCHINE ACCELERATRICI

Presso i laboratori nazionali

- **LNF (Frascati)**
 - DAFNE (collisionatore elettrone-positrone)
 - SPARC (FEL) – il secondo in operazione in Europa
 - Collaborazione con Fermi (Sincrotrone TS)
- **LNL (Legnaro, PD)**
 - 3 acceleratori elettrostatici di ioni: CN, AN2000, Tandem
 - ALPI – linac superconduttore
 - In realizzazione : SPES
 - studio ioni esotici
 - radionuclidi per il medicale
- **LNS (Catania)**
 - Tandem
 - Ciclotrone superconduttore
 - Anche terapia oncologica
 - EXCYT – fasci radioattivi



SPARC



DAFNE



Sala sperimentale

TANDEM

ALPI



TANDEM LNS



CICLOTRONE LNS

MACCHINE ACCELERATRICI

SVILUPPI (esempi)

■ LNF (Frascati)

- Crab waist collision per aumentare la luminosita' nei collisionatori elettroni/positroni
 - Invenzione italiana che sara' usata in Giappone (Belle 2)

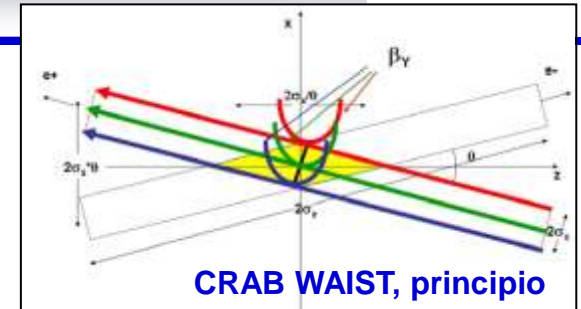

■ LNL (Legnaro, PD)

- RFQ (Radio Frequency Quadrupole): 10 m, protoni 5 MeV con potenza 200 kW (record mondiale)
- Iniettore Pb per LHC (CERN)
- IFMIF (dimostratore di iniettore per ITER)

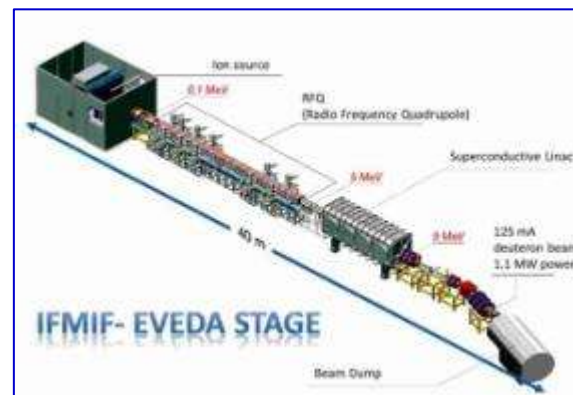

IONIZING PARTICLE DETECTORS

- **WHICH RELEVANCE FOR THE PROGRESS OF PHYSICS?**
 - central while designing an experiment is designing an apparatus, namely a suitable collection of detectors, able to measure the interaction under study with the required performance:
 - resolution efficiency rate capability sample purity
 - up to a large extent the experiment and its apparatus cannot be disentangled →
no progress in physics possible w/o progress in the detector sector
 - detectors are invented, developed, designed and built by the physicists
 - the relevance of detector development is widely recognized
 - an example: NOBEL PRIZE (1993) awarded to George CHARPAK for “for his invention and development of particle detectors, in particular the multiwire proportional chamber”
 - but the list is longer



1927: C.T.R. Wilson, Cloud Chamber
1939: E. O. Lawrence, Cyclotron & Discoveries
1948: P.M.S. Blacket, Cloud Chamber & Discoveries
1950: C. Powell, Photographic Method & Discoveries
1954: Walter Bothe, Coincidence Method & Discoveries
1960: Donald Glaser, Bubble Chamber
1968: Luis Alvarez, Bubble Chamber & Discoveries
1992: Georges Charpak, Multi Wire Proportional Chamber

RIVELATORI, ESEMPI:
tutte realizzazioni di
INFN - TRIESTE

SOLID STATE TRACKERS & TRIESTE



BABAR @ SLAC B-factory

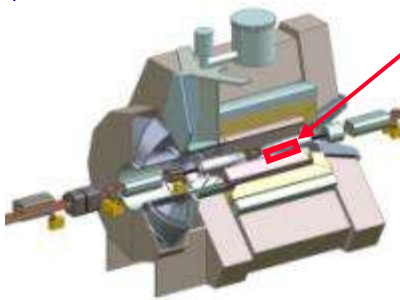

Silicon Vertex Tracker
5 layers (double-sided Si sensors)
vertexing + tracking (+ dE/dx)



FINUDA @ Frascati Φ -factory

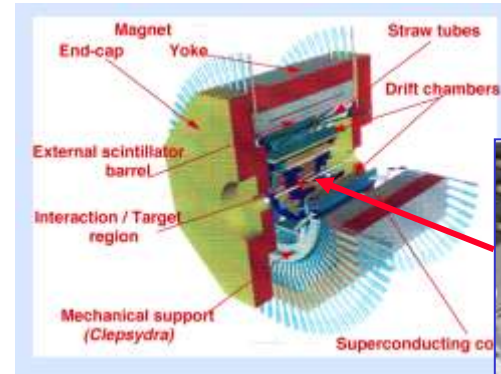

ALICE @ CERN LHC: strips, Si drift detectors

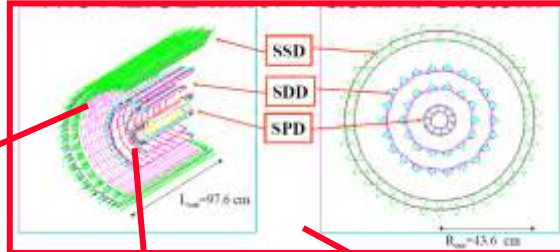

AGILE, space-born exp. for γ astronomy

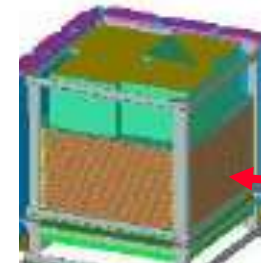



THE PRESENT

MWPCs with CsI photocathodes
for COMPASS RICH-1

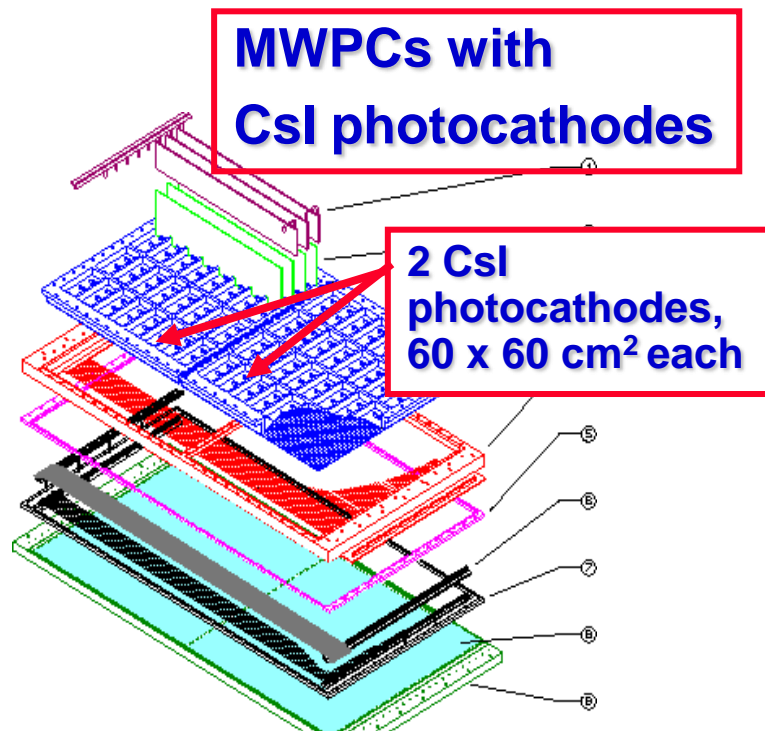

8 chambers, 5.5 m² in total; the largest CsI MWPC system in operation so far

TOWARDS THE FUTURE

R&D: THGEM (Thick GEM) based photon detectors for future applications in COMPASS

Thick GEM-like e-multipliers

- manufactured by standard PCB
- **drilling and Cu etching**
- Coupled to a **reflective photocathode**

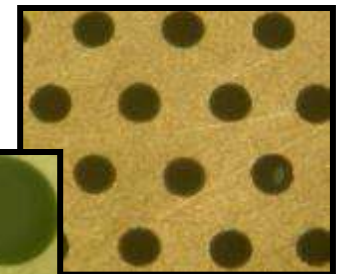
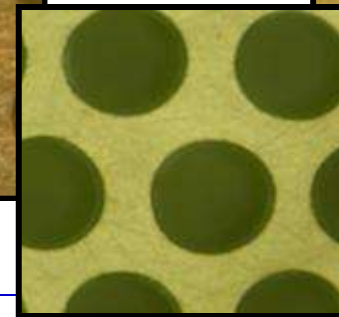
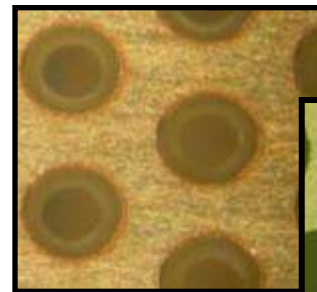

RICHes AND TRIESTE



CAPRICE RICH - the first flying RICH

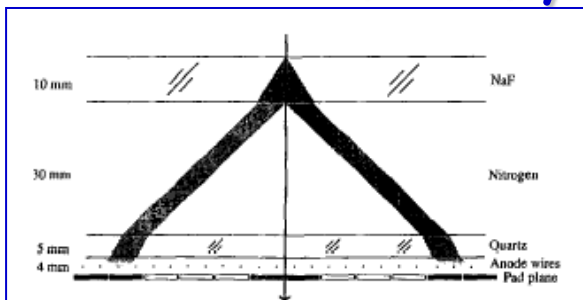

COMPASS RICH-1 upgrade upgrade designed in TS the first *fast* RICH

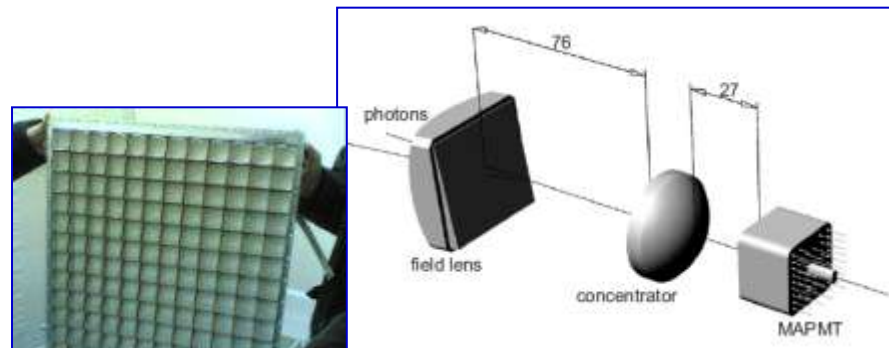

COMPASS RICH-1 - counter designed in TS the largest RICH in operation

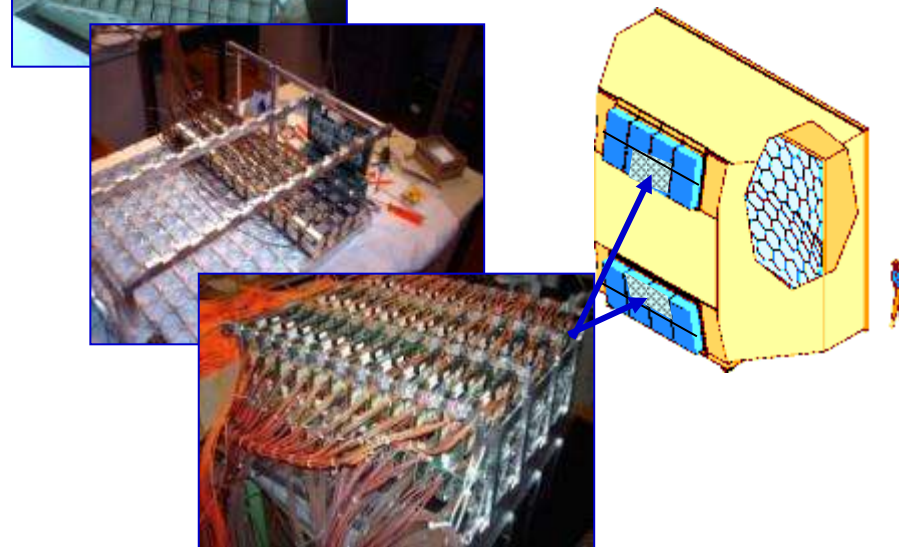
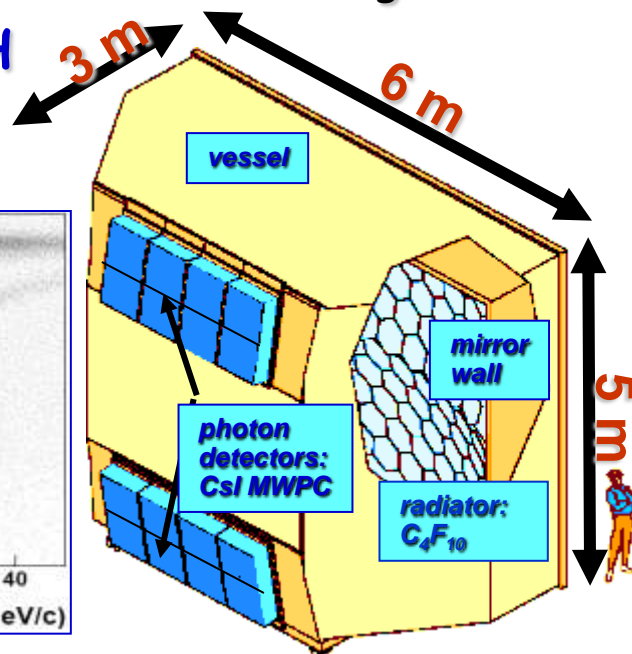
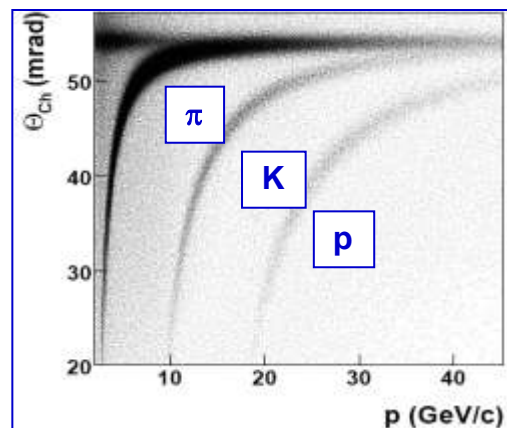

RICH - THE STATUS OF THE ART



High tech solutions

Mirror wall

Large surface (21 m²) covered with 116 mirrors.
Radius of curvature: 6.6 m
VUV reflecting



Radiator: C_4F_m

MIRROR WALL MECHANICS:
the elements of the modular structure

Very good radiator transparency:
at left, transmission through 1.87 m, corresponding to:
 H_2O : ~1 ppm,
 O_2 : ~3 ppm

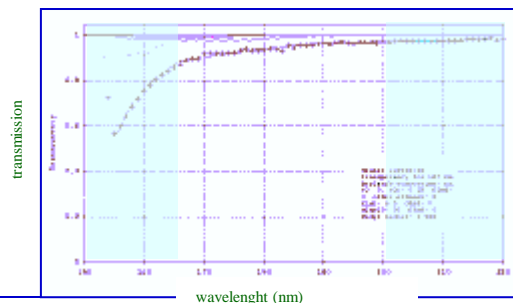

Performance

Before and after the RICH-1 Upgrade

Ring resolution: 0.6 mrad \rightarrow 0.3 mrad

Num. photons per ring at saturation

14 \rightarrow 56

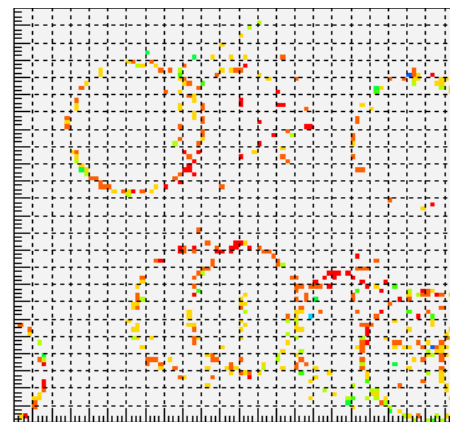

Reconstructed hadron mass spectrum

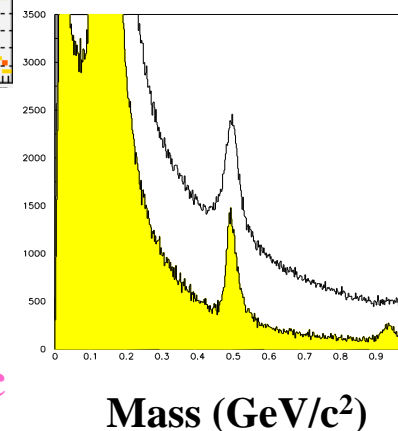

K id efficiency

60% \rightarrow 95%

2σ π -K separation at

43 GeV/c \rightarrow 55 GeV/c

ELECTROMAGNETIC CALORIMETERS

SAMPLING

- Si - Cosmic ray composition in a space-born experiment
Si-W calorimeter for PAMELA

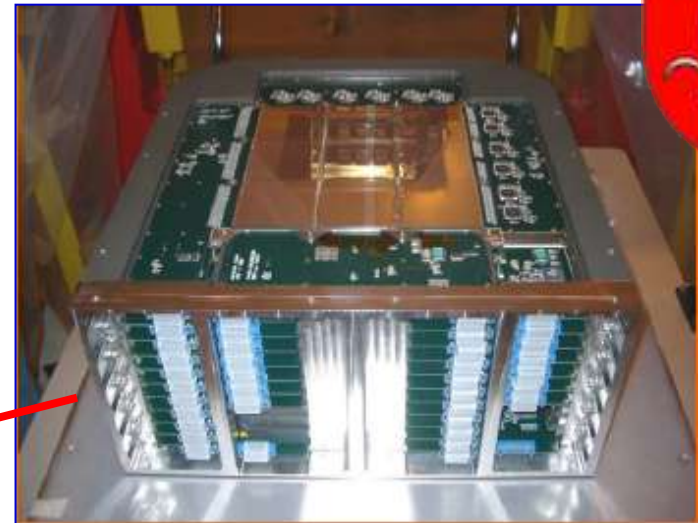
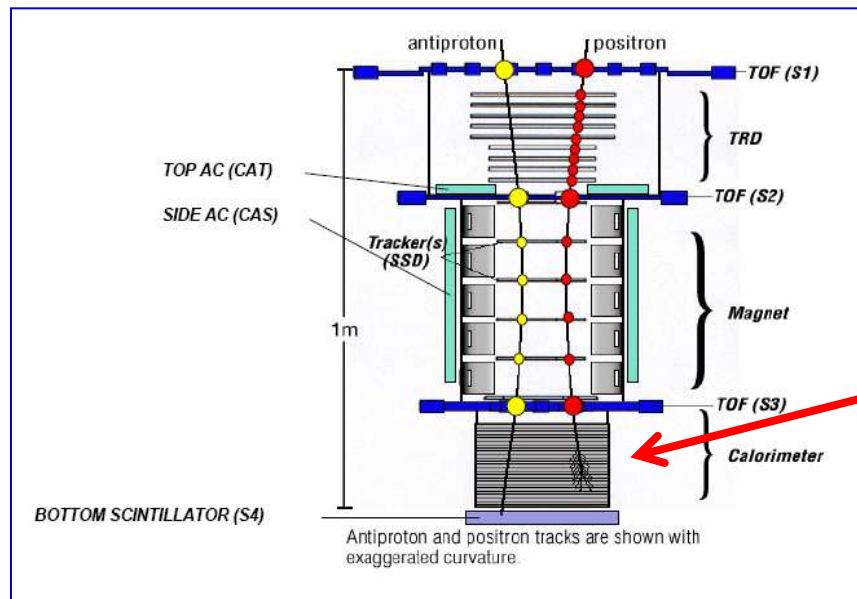

computing power and techniques to digest information in the petabyte range

- about CPU capacity:
@ CERN
5 ORDERS OF MAGNITUDE IN 18 Y

- about amount of data:
 - COMPASS > 0.3 PB / year (running)
 - LHC experiments: 1.5 PB / year (expected)

- about techniques: **the GRID**
 - an infrastructure that provides seamless access to computing power and data storage capacity distributed over the globe

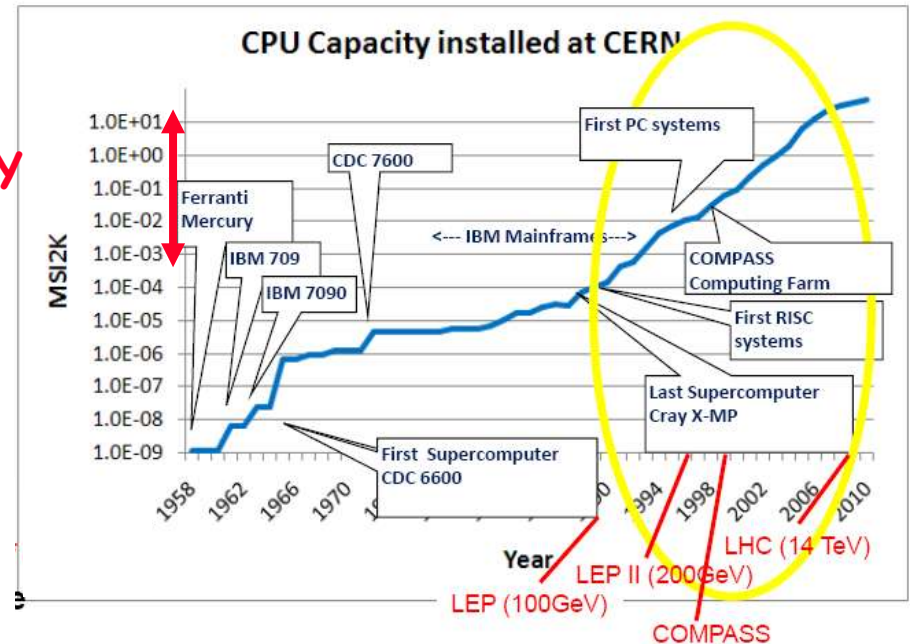



Computer Farm



computer farm is a group of networked servers that are housed in one location. A computer farm streamlines internal processes by distributing the workload between the individual components of the farm and expedites computing processes by harnessing the power of multiple servers. The farms rely on load-balancing software that accomplishes such tasks as tracking demand for processing power from different machines, prioritizing the tasks and scheduling and rescheduling them depending on priority and demand that users put on the network. When one server in the farm fails, another can step in as a backup.

Yesterday (2001): The Compass Trieste Farm

- "White box" dual single core 1 GHz processor PCs, 512 MB RAM (~ 0.8 kSI2k)
- PC disk servers (up to 1 TB/machine), few TB of total storage

First Computer Farm in Italy completely managed by **INFN**

Today (2012): The INFN Trieste Farm

- "Rack-mount" twin-16 core > 2.26 GHz processor PCs, 24 GB RAM (360 HEP-SPEC06 = ~ 125 kSI2k)
- General Parallel File System, 13PB of total storage
- Open to GRID activities

But GRID Tiers, it is one of the biggest INFN farms installed nowadays



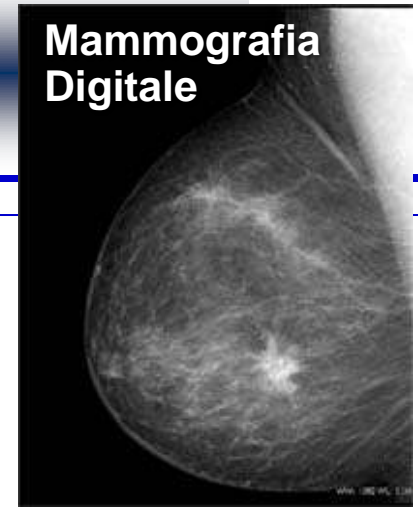

Tecnologie e applicazioni interdisciplinari

■ Applicazioni mediche

- **Diagnostica** (mammografia digitale)
- **Progetto CALMA** : un sistema di acquisizione e di analisi di immagini mammografiche (supporto automatico allo screening)
- **Cura**
 - Tumori dell'occhio a LNS: fasci di protoni dal ciclotrone superconduttore
 - La costruzione del CNAO (Ministero Salute, INFN: co-direzione dell'alta tecnologia): fasci di protoni e ioni di Carbonio per trattamenti oncologici

■ **tecniche non distruttive per la salvaguardia dei beni culturali**

- **Datazione e analisi con tecniche**
 - IBA (Ion Beam Analysis) e
 - AMS (Accelerator Mass Spectrometry)
- **Datazione determinando la presenza di isotopi rari (^{14}C)**



... ECCETERA ...

quanto abbiamo fugacemente visto assieme e' solo un campionario rappresentativo dell'attivita' INFN

INFN - struttura

- **4 Laboratori Nazionali**
 - **LNL** – Laboratori Nazionali di Legnaro
 - **LNGS** - Laboratori Nazionali del Gran Sasso → **ERC Infrastructure**
 - **LNF** - Laboratori Nazionali di Frascati
 - **LNS** - Laboratori Nazionali del SUD
- **2 Centri Tecnico-scientifici**
 - **CNAF** (Bo) – Calcolo
 - **TIFPA** (TN) – rivelatori e fisica medica
- **1 Centro di alta formazione**
 - **GSSI** (GranSasso Scientific Institute)
- **20 “Sezioni” c/o 20 Università** (fra cui **Trieste**)
- **11 “Gruppi Collegati”, c/o Università** (fra cui **Udine**, che è Gruppo collegato di Trieste)



INFN - personale



personale INFN dipendente e associato: 5711 (dati 2012)

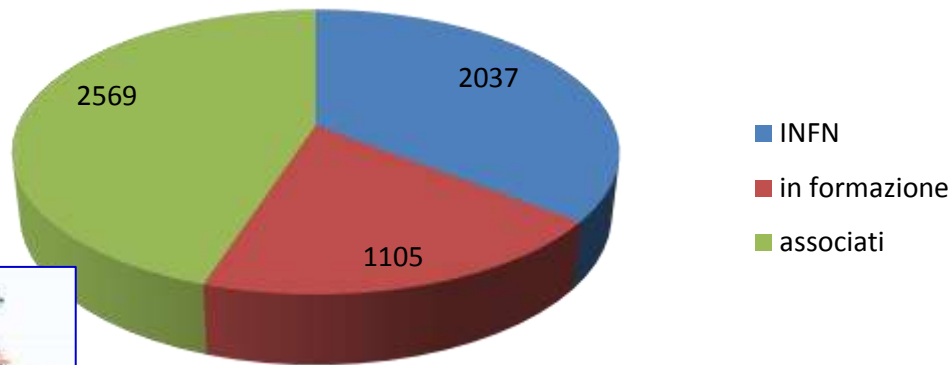

personale INFN dipendente e associato: 5711 (dati 2012)

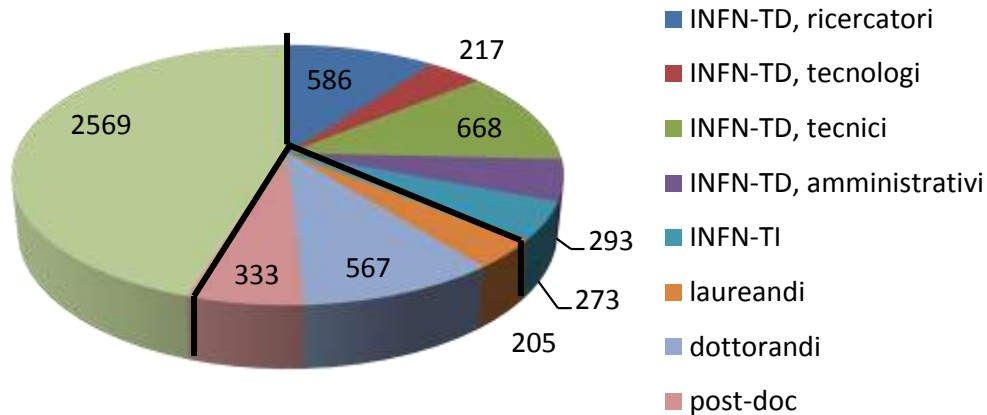

**~270 persone
(55 dipendenti INFN)**

personale, funzione

